

Flexible Heaters

- Isolation Types
- Custom Design
- Temperature Measurement
- Temperature Control



Telemeter Electronic

Thermal Management

Industrial Components

Test & Measurement

RF & Microwaves

Aviation

Engineering & Service



... we provide solutions!

Contents

Selection Form for Heaters	3
Various Carrier Materials (Isolations)	4
Mounting / Adhesive Options	5
Silicone Heater	6
Kapton Heater	7
Custom Solutions	8 – 9
Digital Temperature Controller	10
Notes	11



Various Carrier Materials (Isolations)

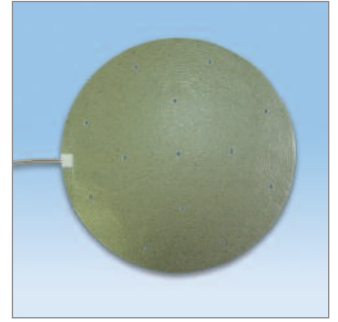
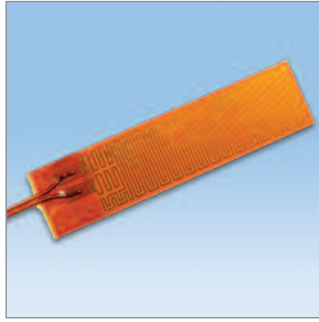

Technical data	Technical data	Silicone Heater	Mica Heater
Isolation	Kapton (Polymide)	Silicone rubber	Mica
Temperature Range	-50°C to 200°C	-60°C to 300°C	20°C to 400°C
Flexibility	High	Medium	No
Vacuum suitability	High	Low	Limited
Chemical Resistance	High	Good	Low
Element Type	Etched Meander	Etched Meander / Wire-wound	Etched Meander
Power density	Medium	High	High
Adhesive Options	Self-Adhesive	Self-Adhesive RTV Silicone-tube Glue	Pressure Plate
Maximal Size	500 mm (width)	Under 900 mm (width)	600 x 1000 mm

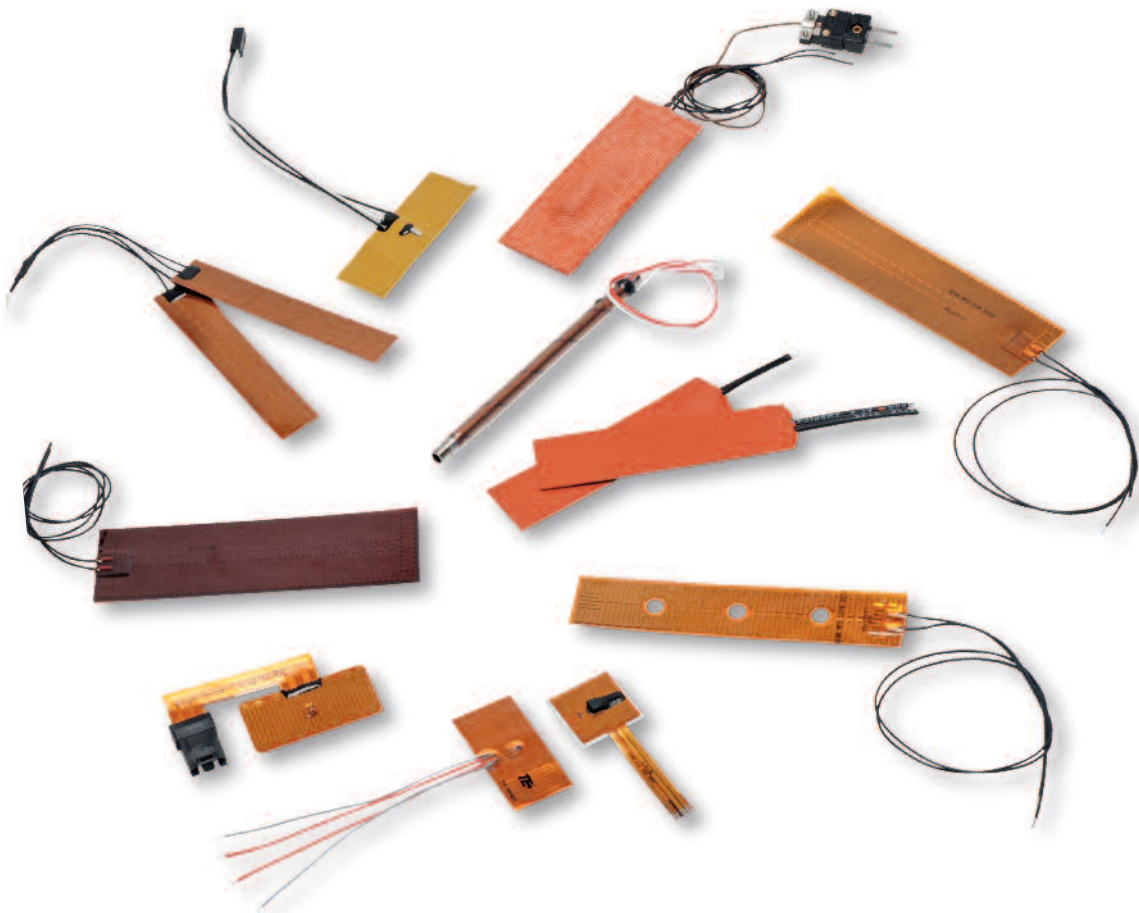

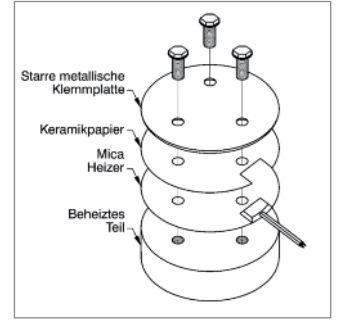
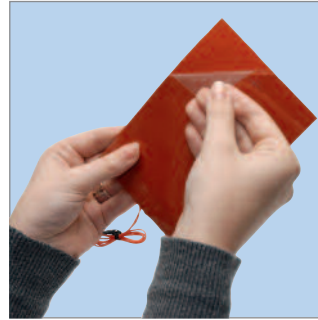
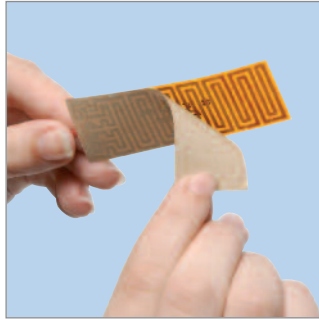

Name	Self-adhesive for Kapton Heater	Self-adhesive for Silicone Heater	Mechanical mounting
Dimensions / Content	According to Heater	According to Heater	Depending on Application
Temperature Range	According to Adhesive Type	According to Adhesive Type	See Temperature Range of Heater
Suitable for	Kapton with aluminum backing	Silicone rubber with aluminum backing	All Heaters
Characteristics	Vacuum suitable, only suitable for flat and slightly curved surfaces	Vacuum unsuitable, only suitable for flat and slightly curved surfaces	Attention on narrow and full contact pressure

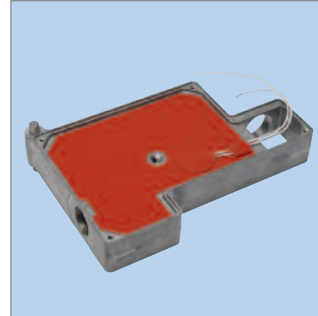

Name	Aluminum backing	Vulcanization	Self-fusing Silicone Tape
Dimensions / Content	According to Heater	According to Heater	Self-fusing Silicone Tape without Adhesive
Temperature Range	According to Adhesive Type	According to Heater	-50°C to +200°C
Suitable for	Kapton- and Silicone Heater	Silicone Heater	Kapton and Silicone Heater
Characteristics	Facilitate the montage on curved surfaces, homogeneous heating transfer	Mechanical fixed, higher power density possible	Applicable on cylindrical surfaces

Useful Information about Silicone Heater

Description

In comparison to Kapton isolated Heaters, flexible Silicone Heaters are cheaper.

Silicone rubber is softer than Kapton and therefore in some cases easier to mount/bond.

Some excellent properties of Silicone rubber are:

- Cheap alternative to Kapton
- High temperature resistance
- Provide the possibility of vulcanize on the heat absorber
- With UL-licence available (on request!)

Following models are available from stock:

Size in mm	Heating power	Resistance in Ohms	Lead length in mm	Description	Part-No.
10 X 10	2,7 W at 5 V	9	500	SI10x10R9L500	47745
20 X 20	6 W at 12 V	24	500	SI20x20R24L500	47746
10 X 50	8 W at 12 V	18	500	SI10x50R18L500	47963
20 X 50	15 W at 12 V	9.6	500	SI20x50R9.6L500	47964
30 X 50	20 W at 12 V	7.2	500	SI30x50R7.2L500	47966
50 X 50	30 W at 24 V	19.2	500	SI50x50R19.2L500	47747
20 X 100	25 W at 12 V	5.8	500	SI20x100R5.8L500	47962
30 X 100	40 W at 24 V	14.4	500	SI30x100R14.4L500	47965
50 X 100	60 W at 24 V	9.6	500	SI100x50R9.6L500	47748
100 X 100	150 W at 48 V	15	500	SI100x100R15L500	47749
200 X 400	800 W at 230 V	66	500	SI200x400R66L500	47750

Ordering scheme

SI... x... R... L...-PSA*

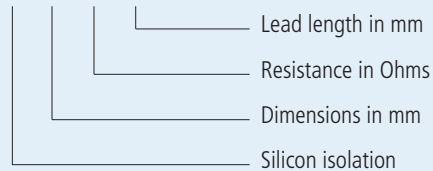

Example:

SI = Silicon isolation
10 x 10 = Dimensions in mm
RXX = Resistance in Ohm
LXXX = Lead length in mm

*PSA

without PSA = without self-adhesive
PSA = with self-adhesive
AL = no self-adhesive, with aluminum backing
PSAAL = with self-adhesive and aluminum backing

Flexible heaters can be customized to suit customer requirements.

Description

Flexible Kapton heater are suitable for applications with reduced space capacity or if the weight of the heating system matters. They are also used for applications where the usage of Silicone isn't wanted.

Some excellent properties of Kapton are:

- Low weight per unit area or per W
- Resistant against lots of chemicals/detergents
- Suitable for vacuum application
- Very flexible, tight bend radius
- With UL-licence available (on request)
- Soldered / welded or laminated leads

Following models are available from stock:

Size in mm	Heating power	Resistance in Ohms	Lead length in mm	Description	Part-No.
10 X 10	2,7 W at 5 V	9	500	KP10x10R9L500	47739
20 X 20	6 W at 12 V	24	500	KP20x20R24L500	47741
10 X 50	8 W at 12 V	18	500	KP10x50R18L500	47958
20 X 50	15 W at 12 V	9.6	500	KP20x50R9.6L500	47959
30 X 50	20 W at 12 V	7.2	500	KP30x50R7.2L500	47961
50 X 50	30 W at 24 V	19.2	500	KP50x50R19.2L500	47742
20 X 100	25 W at 12 V	5.8	500	KP20x100R5.8L500	47957
30 X 100	40 W at 24 V	14.4	500	KP30x100R14.4L500	47960
50 X 100	60 W at 24 V	9.6	500	KP100x50R9.6L500	47744

Ordering scheme

KP... x... R... L...-PSA*

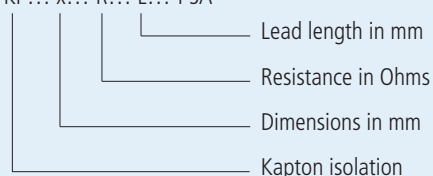

Example:

KI = Kapton isolation
 10 x 10 = Dimensions in mm
 RXX = Resistance in Ohm
 LXXX = Lead length in mm

*PSA

without PSA = without self-adhesive
 PSA = with self-adhesive
 AL = no self-adhesive, with aluminum backing
 PSAAL = with self-adhesive and aluminum backing

Flexible heaters can be customized to suit customer requirements.

Examples of Customized Solutions

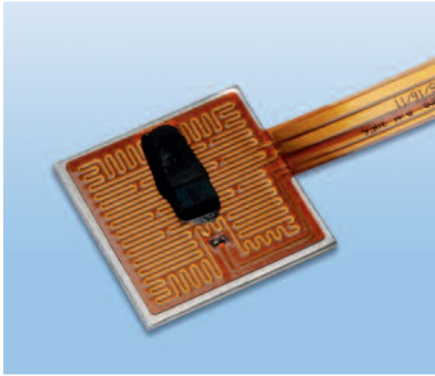

Customized Kapton Heater with connections as flex-version and integrated PT 1000.



Modified Kapton-Heater with connections as flex-version and integrated NTC temperature sensor.

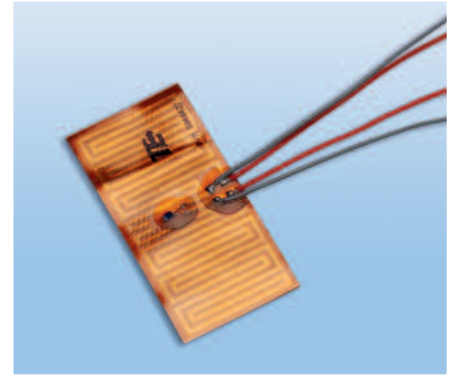

Customized Kapton-Heater with integrated PT100 and aluminum backing.

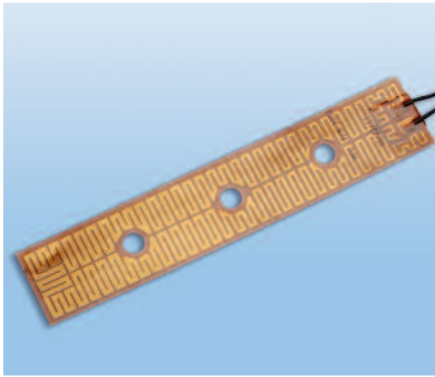

Customized Kapton Heater with holes. Connection leads are welded and laminated between the kapton layers.

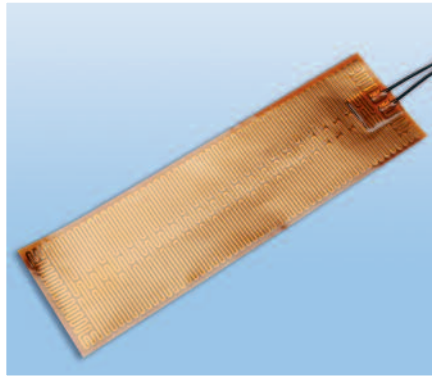

Heating a customized area.

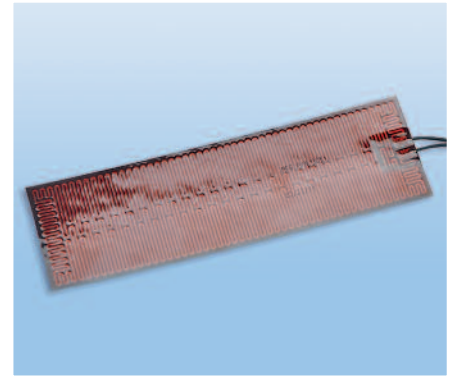

Kapton Heater with aluminum backing. Leads are laminated and welded.



Two Kapton Heaters modified on one plug, with in epoxy resin moulded ports

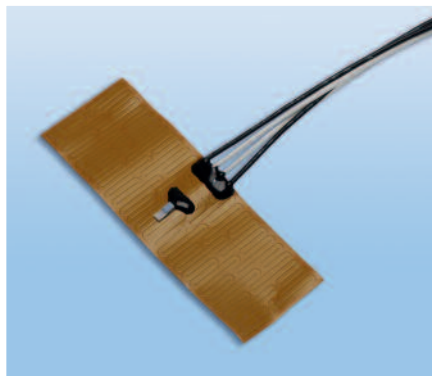

Customized Kapton Heater with aluminum backing and integrated PT1000.



Wire-wound Silicone Heater with robust power cable execution.

We provide solutions!

We will be glad to provide you a customized flexible Heater solution. Therefore we need your specification like power supply, heating power, dimensions, recesses, holes or integrated sensors etc.



Silicone Heater in splash proofed silicone with integrated thermocouple and modified plug.

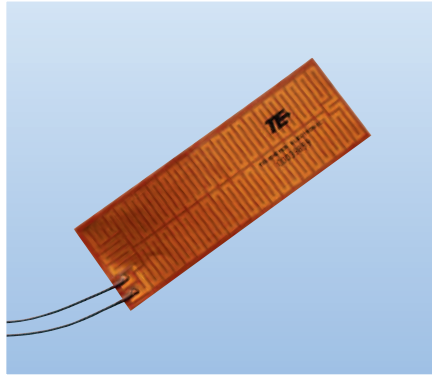

Heating a customized area

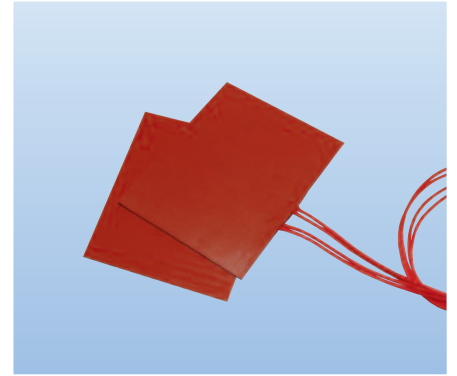

Heater for exhaust gas analysis system to optimal reproduction of measurement, modified with plug.

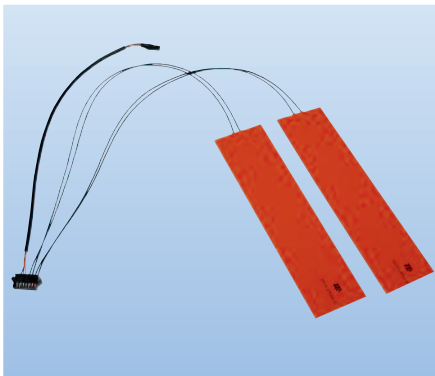

Heating a ticket system with digital temperature sensors, modified with plug.

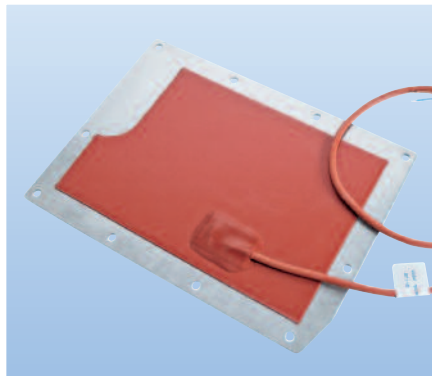

Heating a metal plate with integrated bimetal switch and fuse as emergency shutdown, modified cable.



Temperature range extension of a decoder from -15°C to -46°C

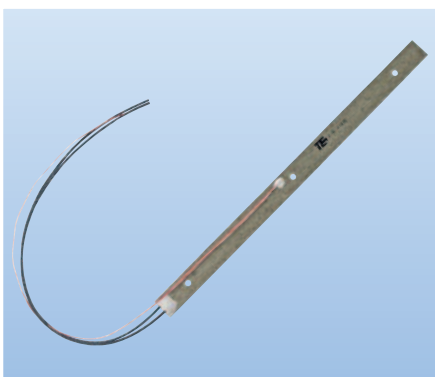

Custom specific mica heater with mounted thermocouple type J



Silicone heater with integrated bimetal switch made of emission free silicone for e.g. railway applications

After installation of a fan, the heated air from a heater will be led into a control. After reaching the final temperature, an installed HiRel-thermostat switched the system off.

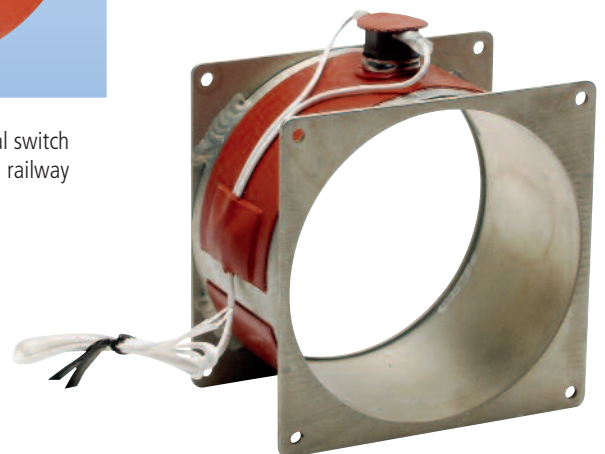

Digital Temperature Controller

Our TR12 was especially developed for thermal control or other electric heating elements, which should be operated with a voltage from 9 V DC to 50 V DC and a switch current up to 12 A (controller model TR12). To control our TR12, Pt100 platinum resistance sensors can be used. The digital working controller reacts to smallest temperature changes at Pt100-sensors and the electrical power will be increased/reduced as needed. Therefore the preset temperature will be held precise and constant at the set point.

Characteristics

- Reliable and inexpensive digital controller
- Ideal for regulation of flexible Heaters
- For switch current to 12 A
- For supply voltage to 50 V DC
- Only one supply voltage needed for controller and consumer up to 600 W performance
- Excellent operational – also at large fluctuations in the supply voltage
- The power transistors switch nearly without loss, therefore hardly self-heating.
- Simple setting of the set point.
- Optical display from switching state with LED
- Allows selection of Pt-100-sensors
- Optional for larger order-lots also available in shed form (exposed resin-grouting)

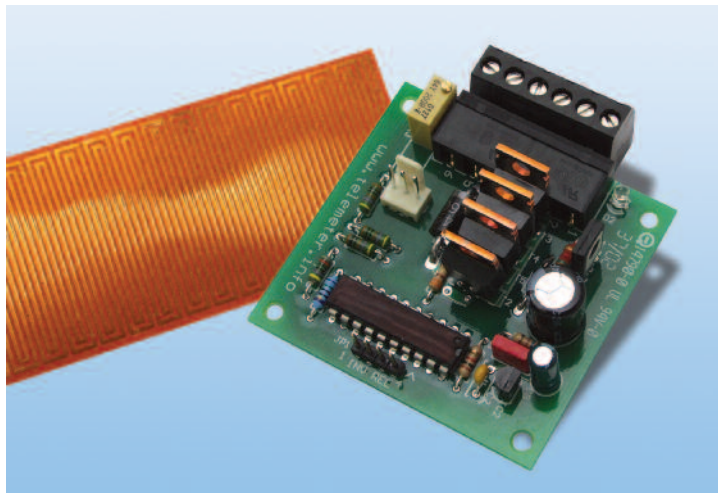

Electrical specifications

	Model TR12
Voltage	9... 50 V DC
Max. Load Current	12 A
Internal Consumption	15...35 mA
Sensor Current	ca. 3,0 mA
Control Range (with Pt100, without load)	-50 to +250°C
Regulation Princip	Digital two-position Controller
Measure Method	Voltage comparison with comparator
Measure Interval	20 ms/200 ms
Sampling Frequency	1 kHz
Hysteresis	<0,5 K
Sensor	Pt100, 2-conductor connection
Dimensions	56 x 58 x 25 mm
Operating Temperature	0°C ... 50°C

Dimensions

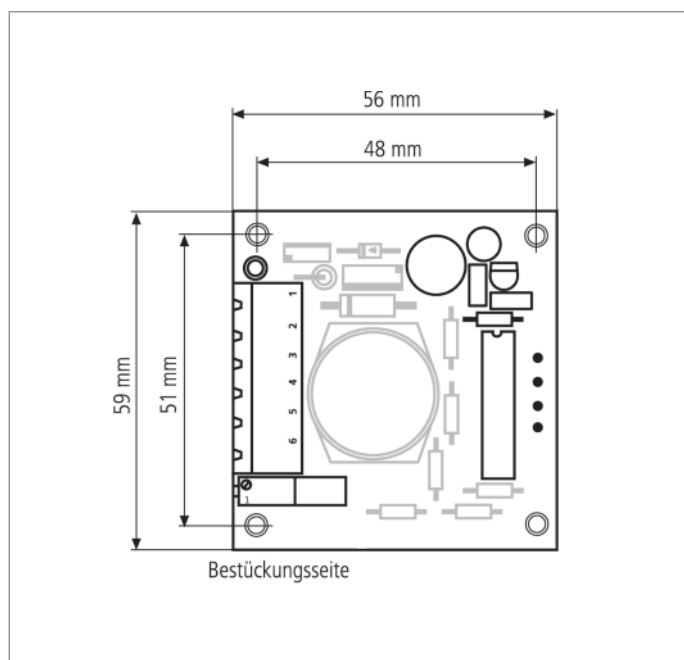

Circuit plan

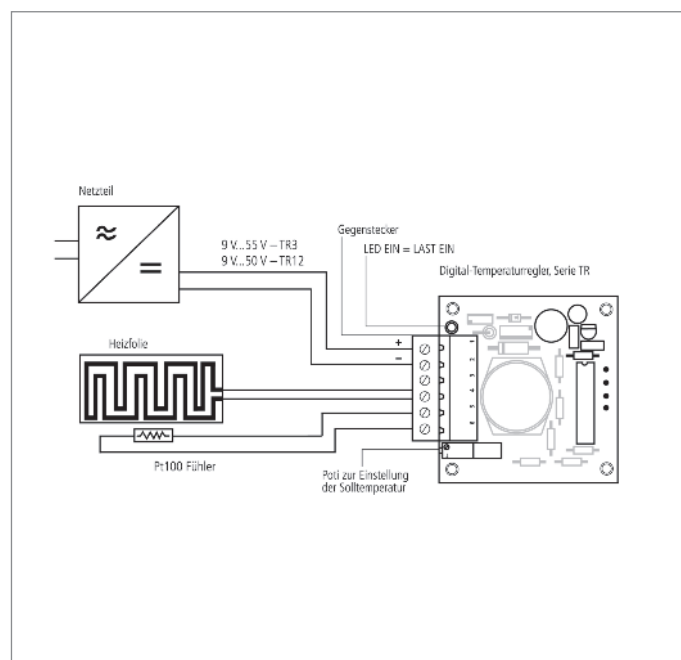



Germany

Telemeter Electronic GmbH

Joseph-Gaensler-Straße 10
86609 Donauwoerth
Phone +49 906 70693-0
Fax +49 906 70693-50
info@telemeter.de
www.telemeter.info

Switzerland

Telemeter Electronic GmbH

Romanshorerstrasse 117
8280 Kreuzlingen
Phone +41 71 6992020
Fax +41 71 6992024
info@telemeter.ch
www.telemeter.info

Czech Republic

Telemeter Electronic s.r.o.

České Vrbné 2364
37011 České Budějovice
Phone +420 385310637
Phone +420 385510143
info@telemeter.cz
www.telemeter.info