

D-SUB BACKSHELLS

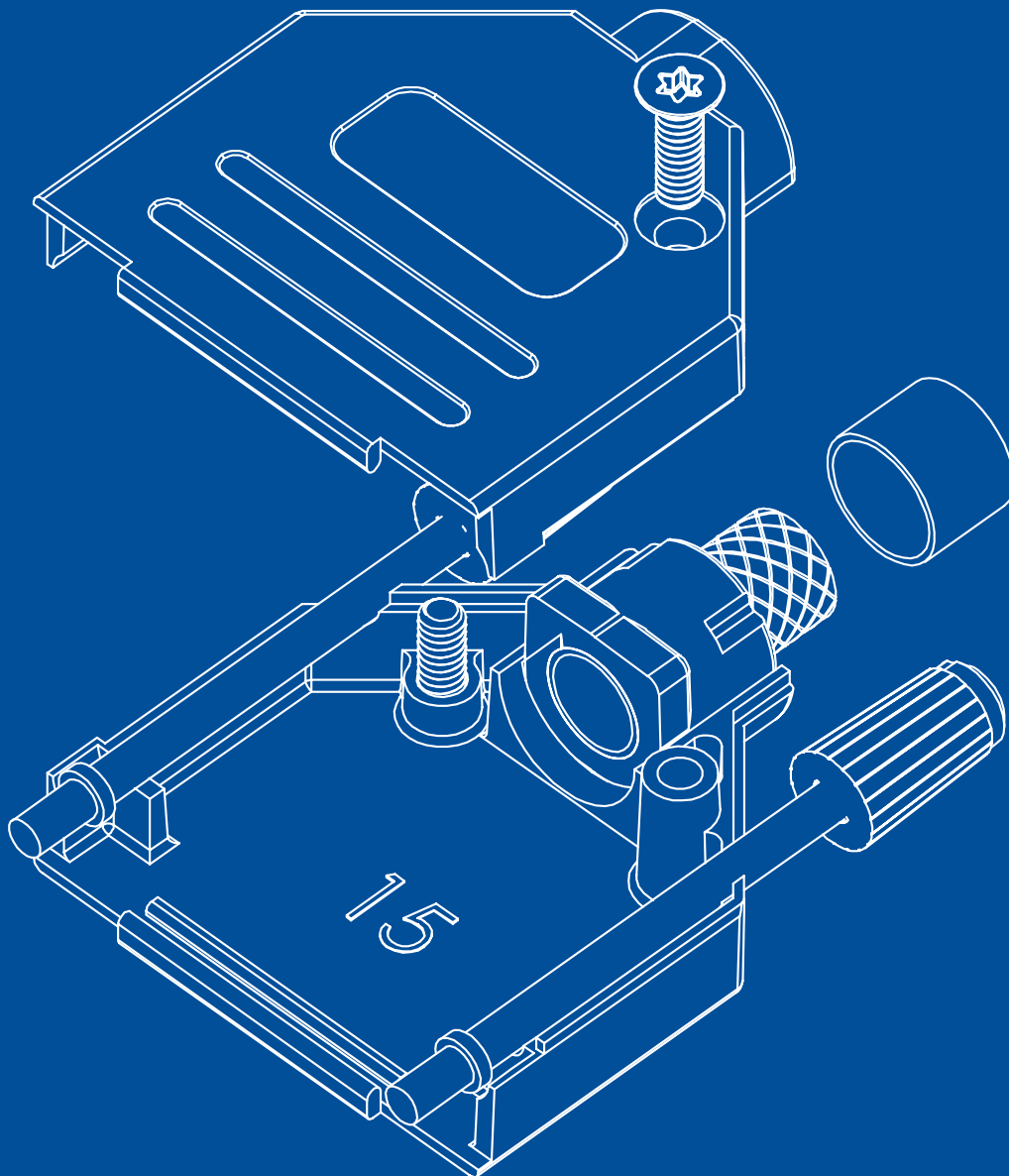

LINECARD EMI/RFI SHIELDED D-SUB BACKSHELLS

OSSI®: CONNECT TO EXCELLENCE

D-SUB BACKSHELLS CATALOGUE / EDITION 05

OSSI®
CONNECTORS

CONNECTORS, PARTS AND
EXCELLENCE SINCE 1974



SERIES	DTZK	DVZK	DTPMK	DVPMK	DTZK-CZA	DTZK-CZAK
SHELL SIZES	9/15/25/37/50	9/15/25/37/50	9/15/25/37	9/15/25/37	9/15/25/37/50	9/15/25/37/50
STANDARD MATERIAL	ZINC	ZINC	MET. PLASTIC	MET. PLASTIC	ZINC	ZINC
CONNECTOR APPLICATIONS						
D-SUB SOLDER CONNECTOR	YES	YES	YES	YES	YES	YES
D-SUB CRIMP CONNECTOR	YES	YES	YES	YES	YES	YES
D-SUB MIXED LAYOUT CONNECTOR	YES	YES	YES	YES	YES	YES
D-SUB FLAT CABLE IDC CONNECTOR	NO	NO	NO	NO	NO	NO
CABLE APPLICATIONS						
ROUND CABLE	YES	YES	YES	YES	YES	YES
FLAT ROUND CABLE	YES	YES	YES	YES	YES	YES
FLAT CABLE	NO	NO	NO	NO	NO	NO
FEATURES						
UL COMPLIANCE	UL94 V0	UL94 V0	UL94 V2	UL94 V2	UL94 V0	UL94 V0
ROHS	YES	YES	YES	YES	YES	YES
REACH	YES	YES	YES	YES	YES	YES
PFOA / PFOB FREE	YES	YES	YES	YES	YES	YES
HALOGEN FREE	YES	YES	YES	YES	YES	YES
TERMINATION	SHIELD CLAMP	SHIELD CLAMP	SHIELD CLAMP	SHIELD CLAMP	CRIMP FERRULE	CRIMP FERRULE
CABLE OUTLET	180°	45°	180°	45°	180°	180°
CABLE BOOT	NO	NO	NO	NO	NO	NO
LOCKING DEVICES						
LONG JACK SCREWS	YES	YES	YES	YES	YES	YES
SLIDE LOCK	NO	NO	NO	NO	NO	NO
SHORT LOCKING SCREWS	NO	NO	NO	NO	NO	NO



SERIES	DVZK-CZA	DVZK-CZAK	DTNMK	DVNMK	DVZK-SL	DVZK-W
SHELL SIZES	9/15/25/37/50	9/15/25/37/50	9/15/25/37/50	9/15/25/37/50	9/15/25/37	9/15/25/37
STANDARD MATERIAL	ZINC	ZINC	ZINC	ZINC	ZINC	ZINC
CONNECTOR APPLICATIONS						
D-SUB SOLDER CONNECTOR	YES	YES	YES	YES	YES	YES
D-SUB CRIMP CONNECTOR	YES	YES	YES	YES	YES	YES
D-SUB MIXED LAYOUT CONNECTOR	YES	YES	YES	YES	YES	YES
D-SUB FLAT CABLE IDC CONNECTOR	NO	NO	NO	NO	NO	NO
CABLE APPLICATIONS						
ROUND CABLE	YES	YES	YES	YES	YES	YES
FLAT ROUND CABLE	YES	YES	YES	YES	YES	YES
FLAT CABLE	NO	NO	NO	NO	NO	NO
FEATURES						
UL COMPLIANCE	UL94 V0	UL94 V0	UL94 V0	UL94 V0	UL94 V0	UL94 V0
ROHS	YES	YES	YES	YES	YES	YES
REACH	YES	YES	YES	YES	YES	YES
PFOA / PFOB FREE	YES	YES	YES	YES	YES	YES
HALOGEN FREE	YES	YES	YES	YES	YES	YES
TERMINATION	CABLE FERRULE	CABLE FERRULE	SHIELD CLAMP	SHIELD CLAMP	SHIELD CLAMP	SHIELD CLAMP
CABLE OUTLET	45°	45°	180°	45°	45°	45°
CABLE BOOT	NO	NO	NO	NO	NO	NO
LOCKING DEVICES						
LONG JACK SCREWS	YES	YES	YES	YES	NO	YES
SLIDE LOCK	NO	NO	NO	NO	YES	NO
SHORT LOCKING SCREWS	NO	NO	NO	NO	NO	NO



SERIES	DMTZK	DMTZK-SL	DMVZK	DMVZK-SL	DSZK	DSZK-SL
SHELL SIZES	9/15	9/15	9/15	9/15	9/15	15/25
STANDARD MATERIAL	ZINC	ZINC	ZINC	ZINC	ZINC	ZINC
CONNECTOR APPLICATIONS						
D-SUB SOLDER CONNECTOR	YES	YES	YES	YES	YES	YES
D-SUB CRIMP CONNECTOR	YES	YES	YES	YES	YES	YES
D-SUB MIXED LAYOUT CONNECTOR	YES	YES	YES	YES	YES	YES
D-SUB FLAT CABLE IDC CONNECTOR	NO	NO	NO	NO	NO	NO
CABLE APPLICATIONS						
ROUND CABLE	YES	YES	YES	YES	YES	YES
FLAT ROUND CABLE	YES	YES	YES	YES	YES	YES
FLAT CABLE	NO	NO	NO	NO	NO	NO
FEATURES						
UL COMPLIANCE	UL94 V0	UL94 V0	UL94 V0	UL94 V0	UL94 V0	UL94 V0
ROHS	YES	YES	YES	YES	YES	YES
REACH	YES	YES	YES	YES	YES	YES
PFOA / PFOB FREE	YES	YES	YES	YES	YES	YES
HALOGEN FREE	YES	YES	YES	YES	YES	YES
TERMINATION	CABLE CLAMP	CABLE CLAMP	CABLE CLAMP	CABLE CLAMP	SHIELD CLAMP	SHIELD CLAMP
CABLE OUTLET	180°	180°	45°	45°	90°	90°
CABLE BOOT	YES	YES	YES	YES	NO	NO
LOCKING DEVICES						
LONG JACK SCREWS	YES	NO	YES	NO	YES	NO
SLIDE LOCK	NO	YES	NO	YES	NO	YES
SHORT LOCKING SCREWS	YES	NO	YES	NO	NO	NO

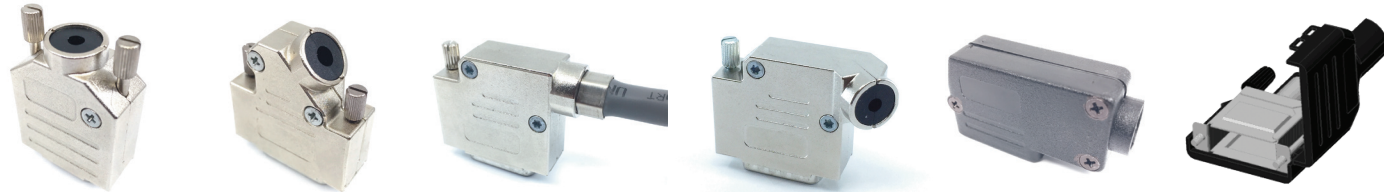

SERIES	DTZK-JSS	DVZK-JSS	DSZK-CZA	DSVZK	DSK-SL	DTK
SHELL SIZES	9/15/25/37/50	9/15/25/37/50	9/15	15	9/15/25/37*	9/15/25/37*
STANDARD MATERIAL	ZINC	ZINC	ZINC	ZINC	POLYCARBONATE	PA 9/15/37 PC 25
CONNECTOR APPLICATIONS						
SUB-D SOLDER CONNECTOR	YES	YES	YES	YES	YES	YES
SUB-D CRIMP CONNECTOR	YES	YES	YES	YES	YES	YES
SUB-D MIXED LAYOUT CONNECTOR	YES	YES	YES	YES	YES	YES
SUB-D FLAT CABLE IDC CONNECTOR	NO	NO	NO	NO	YES	YES
CABLE APPLICATIONS						
ROUND CABLE	YES	YES	YES	YES	YES	YES
FLAT ROUND CABLE	YES	YES	YES	YES	YES	YES
FLAT CABLE	NO	NO	NO	NO	NO	NO
FEATURES						
UL COMPLIANCE	UL94 V0	UL94 V0	UL94 V0	UL94 V0	UL94 V0	UL94 VO / UL94 V2
ROHS	YES	YES	YES	YES	YES	YES
REACH	YES	YES	YES	YES	YES	YES
PFOA / PFOB FREE	YES	YES	YES	YES	YES	YES
HALOGEN FREE	YES	YES	YES	YES	YES	YES
TERMINATION	SHIELD CLAMP	SHIELD CLAMP	CRIMP FERRULE	SHIELD CLAMP	CRIMP FERRULE	CRIMP FERRULE
CABLE OUTLET	180°	45°	90°	90°/45°	90°	180°
CABLE BOOT	NO	NO	NO	NO	NO	NO
LOCKING DEVICES						
LONG JACKSCREWS	YES	YES	YES	YES	NO	YES
SLIDE LOCK	NO	NO	NO	NO	YES	NO
SHORT LOCKING SCREWS	NO	NO	NO	NO	NO	NO

CONNECT TO OSSI

DISCOVER OUR PRODUCTS, SERVICES AND
ONLINE CATALOGUES AT WWW.OSSI.DK

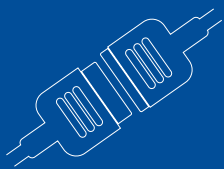

MAIN
CATALOGUE

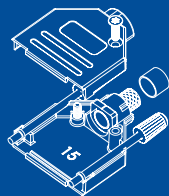

D-SUB
BACKSHELLS

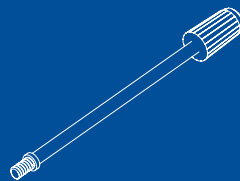

D-SUB
ACCESSORIES

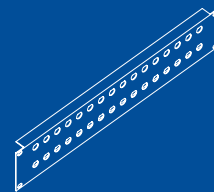

19" PATCH
PANELS

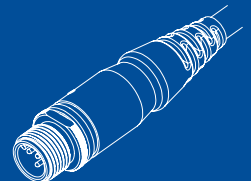

M12 CIRCULAR
CONNECTORS

OSSI[®]
CONNECTORS
CONNECTORS, PARTS AND
EXCELLENCE SINCE 1974

OSSI CONNECTORS A/S
ANKER JØRGENSENS VEJ 2
DK-4930 MARIBO
DENMARK
WEB: WWW.OSSI.DK
TEL: +45 54 78 28 88
E-MAIL: INFO@OSSI.DK

ALL RIGHTS RESERVED ©1974-2018 OSSI CONNECTORS A/S. OSSI[®] IS A REGISTERED TRADEMARK. LAND DESIGNLAB FOR OSSI CONNECTORS 10.18>